

### 齿轮铣刀

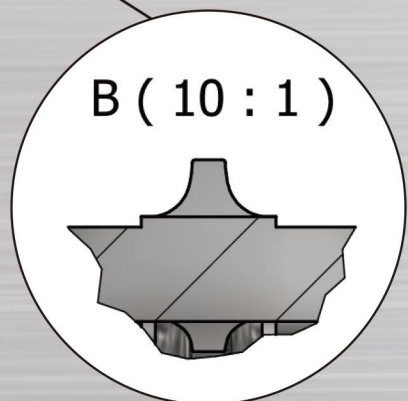

C-C (5:1)

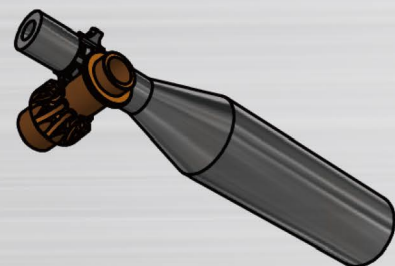
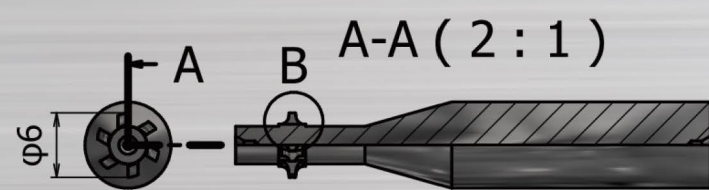
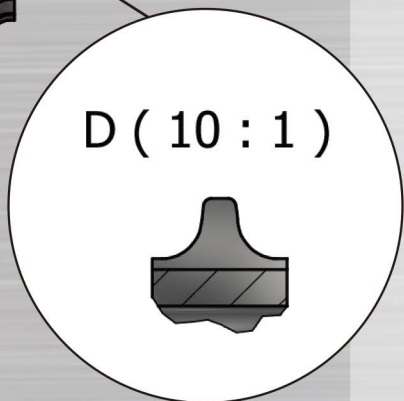
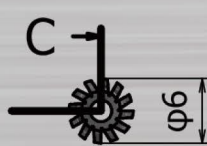

使用例

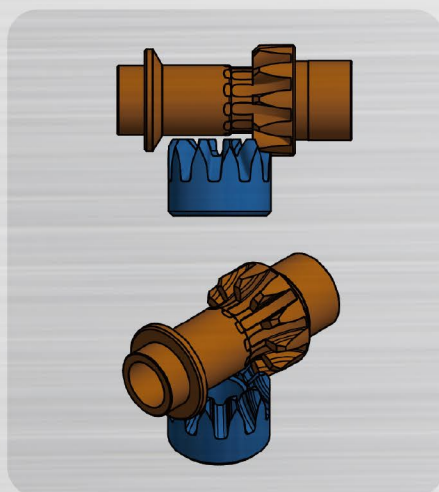
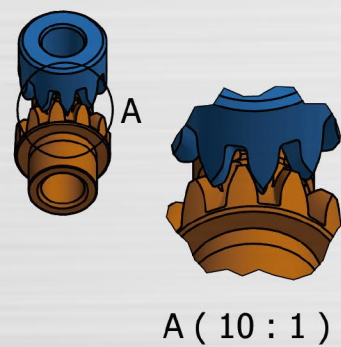

### 7片刃刀(直齿圆锥齿轮)

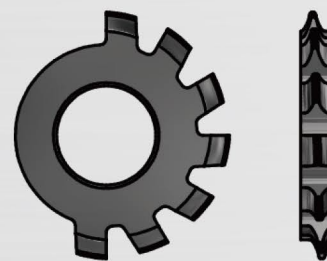

使用例

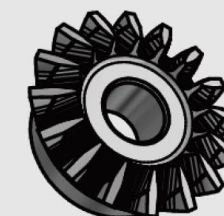
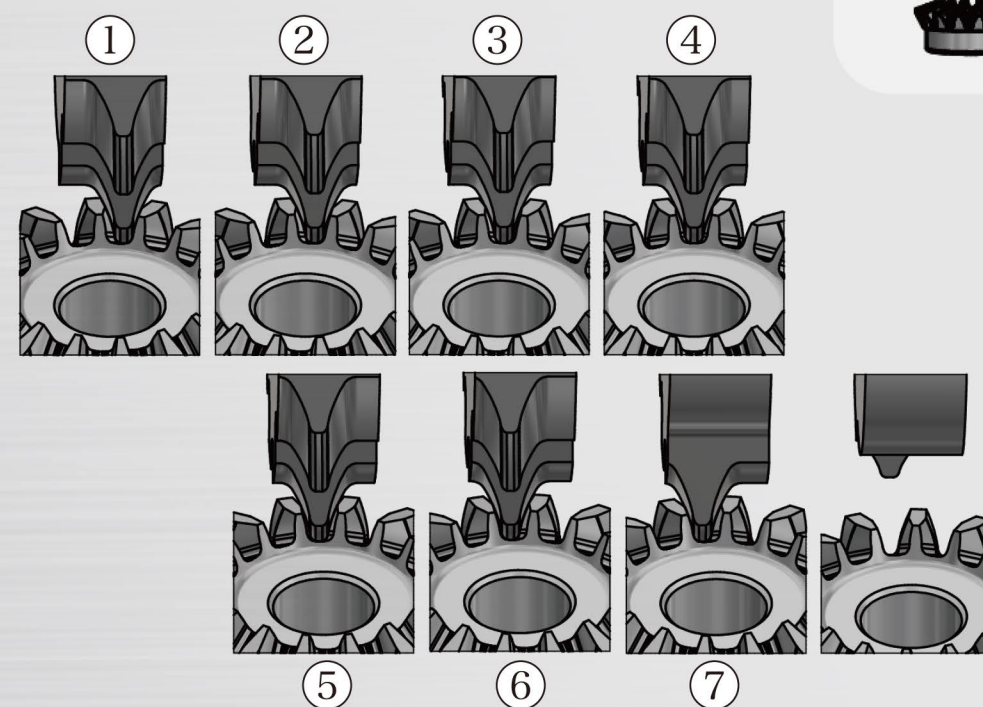
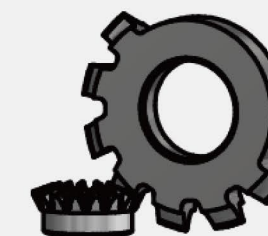

齿轮铣刀(1片刃·2片刃·3片刃刀)

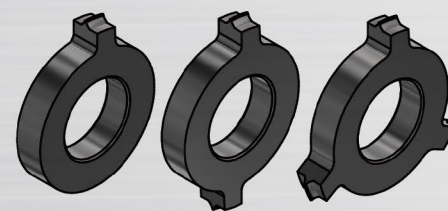

使用例

